

END COVER COLOR: BLACK

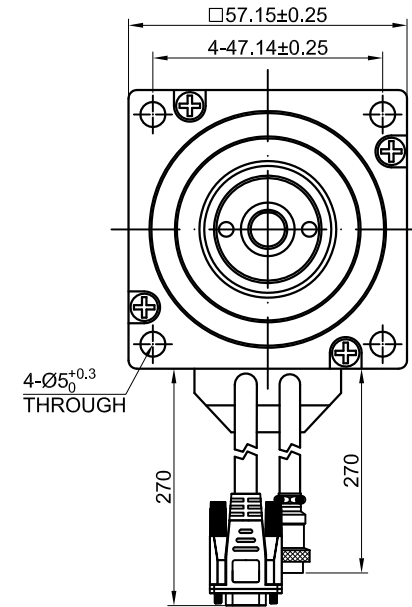

4-PIN GX16 FEMALE PLUG 15-PIN DB MALE PLUG

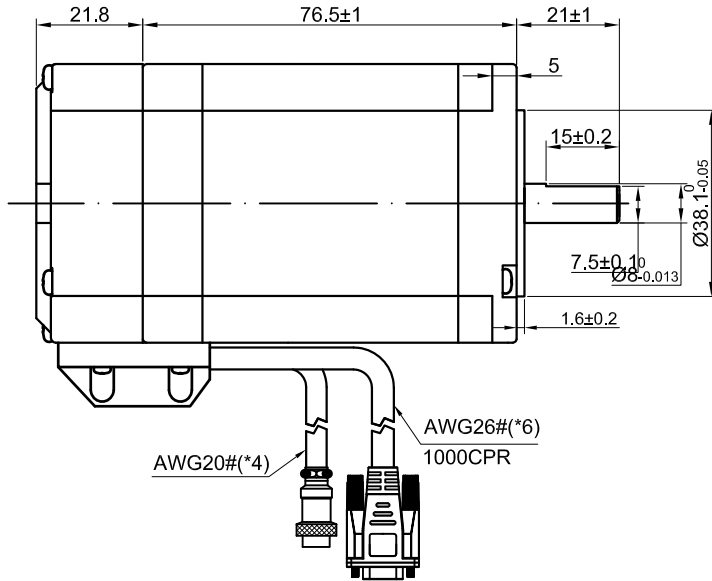
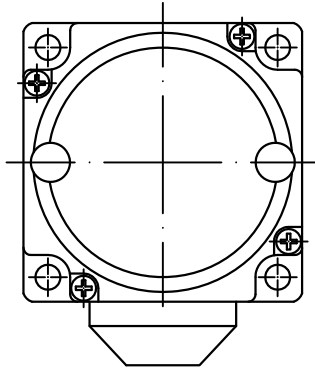
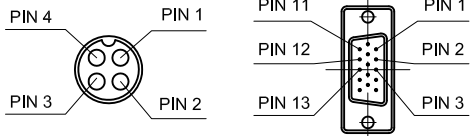

SPECIFICATION	CONNECTION	BIPOLAR
AMPS/PHASE		5.00
RESISTANCE/PHASE(Ohms)@20°C		0.40±10%
INDUCTANCE/PHASE(mH)@1KHz		1.80±20%
HOLDING TORQUE(Nm)[lb-in]		2.00 [17.71]
STEP ANGLE(°)		1.8±0.09
MAXIMUM RADIAL RUNOUT(mm)@LOAD 450g		0.025
MAXIMUM AXIAL RUNOUT(mm)@LOAD 920g		0.075
ROTOR INERTIA(g-cm ²)		480
WEIGHT(Kg)[lb]		—
TEMPERATURE RISE:MAX.80°C (MOTOR STANDSTILL;FOR 2PHASE ENERGIZED)		
OPERATION AMBIENT TEMPERATURE 0°C~50°C[32°F~122°F]		
INSULATION RESISTANCE 100 Mohm (UNDER NORMAL TEMPERATURE AND HUMIDITY)		
INSULATION CLASS B 130°C[266°F]		
DIELECTRIC STRENGTH 500VAC FOR 1MIN.(BETWEEN THE MOTOR COILS AND THE MOTOR CASE)		

TYPE OF CONNECTION (EXTERN)		MOTOR	
PIN NO	BIPOLAR	LEADS	WINDING
1	A+ —		A+
2	A- —		A-
3	B+ —		B+
4	B- —		B-

FULL STEP 2 PHASE-Ex. ,
WHEN FACING MOUNTING END (X)

STEP	A+	B+	A-	B-	CCW	CW
1	+	+	-	-		
2	-	+	+	-		
3	-	-	+	+		
4	+	-	-	+		

ENCODER RESOLUTION:1000PPR(4000CPR)

15-PIN DB MALE PLUG	1	2	3	11	12	13
DESCRIPTION	EA+	VCC	GND	EB+	EB-	EA-



APVD		10.16.2021
CHKD		
1:1.5	DRN	
SCALE	SIGNATURE	DATE

STEPPER MOTOR

23E1K-20