

TEC2418

24mm brushless motor

Connection Mode A	
Clockwise Rotation/Counter Clockwise Rotation	
FG Signal	
PWM Control	
Locked Rotor Protection	
Power	3W(Internal Drive) /
Life Expectancy	~3000H(Oil Bearing) /

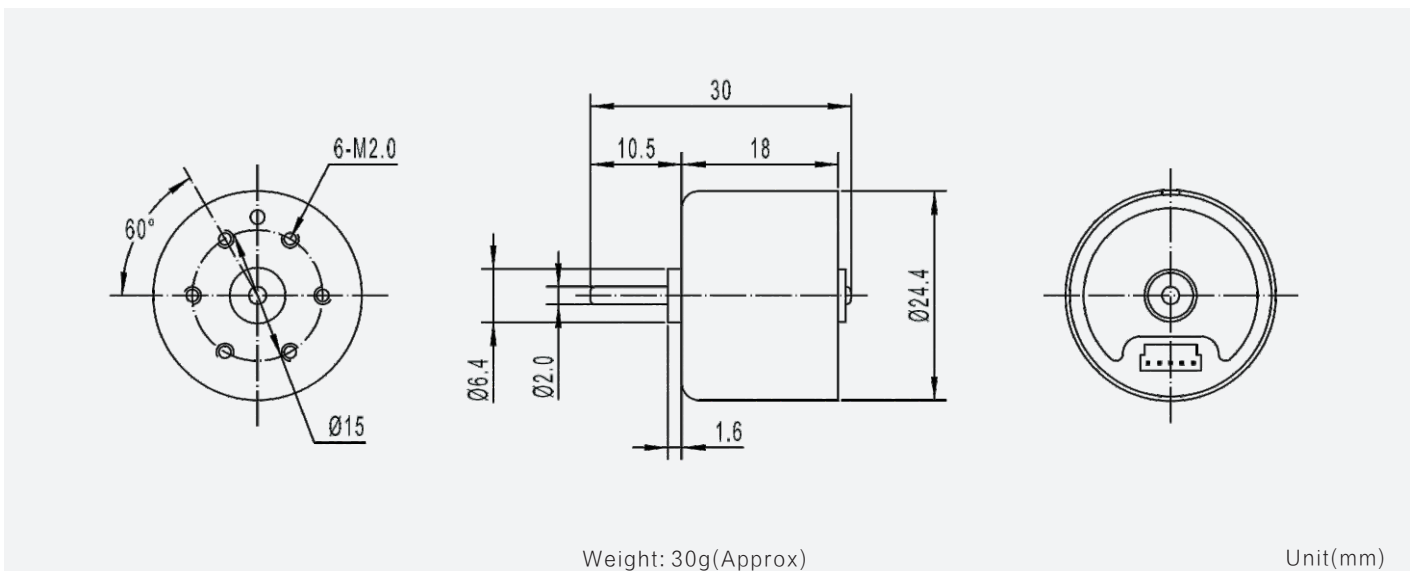

Motor Technical Data

Motor model	Rated voltage	No-load		Rated				Stall	
		Speed	Current	Speed	Torque	Current	Power	Torque	Current
	VDC	r/min	mA	r/min	g.cm	mA	W	g.cm	A
TEC2418-1262	12.0	6200	60	5100	20	180	1.05	110	0.7
TEC2418-2487	24.0	8700	50	7500	20	130	1.54	145	0.7

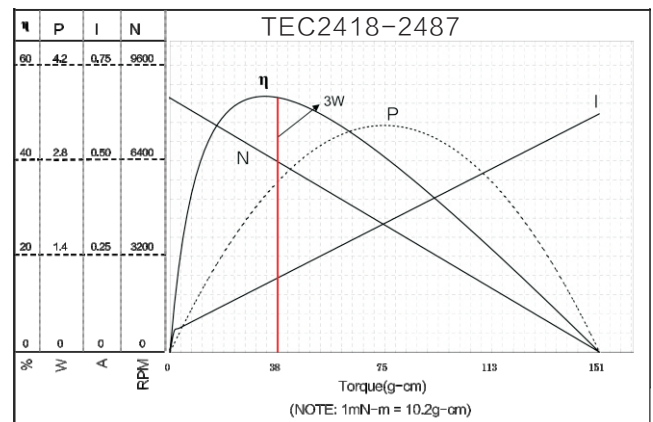
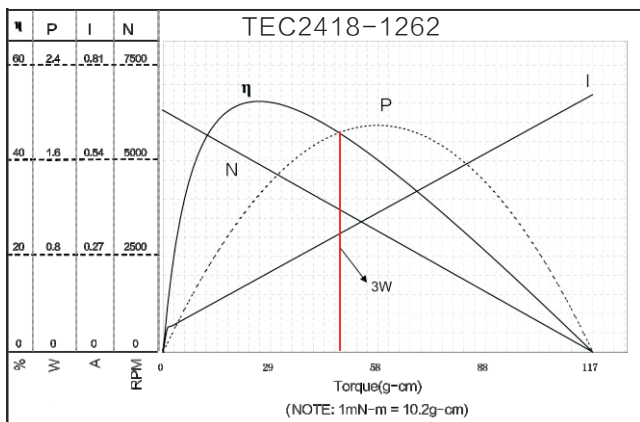

NOTE: the left side of red line area can continuous work